

**PMC-220**  
**Single-Phase Multifunction Meter**  
**User Manual**  
**Version: V1.03A**  
May 4, 2023



This manual may not be reproduced in whole or in part by any means without the express written permission from CET.

The information contained in this manual is believed to be accurate at the time of publication; however, CET assumes no responsibility for any errors which may appear here and reserves the right to make changes without notice. Please consult CET or your local representative for the latest product specifications.

## Standards Compliance



### **DANGER**

This symbol indicates the presence of danger that may result in severe injury or death and permanent equipment damage if proper precautions are not taken during the installation, operation or maintenance of the device.



### **CAUTION**

This symbol indicates the potential of personal injury or equipment damage if proper precautions are not taken during the installation, operation or maintenance of the device.



**Failure to observe the following instructions may result in severe injury or death and/or equipment damage.**

- Installation, operation and maintenance of the meter should only be performed by qualified, competent personnel that have the appropriate training and experience with high voltage and current devices. The meter must be installed in accordance with all local and national electrical codes.
- Ensure that all incoming AC power and other power sources are turned OFF before performing any work on the meter.
- Before connecting the meter to the power source, check the label on top of the meter to ensure that it is equipped with the appropriate power supply, and the correct voltage and current input specifications for your application.
- During normal operation of the meter, hazardous voltages are present on its terminal strips and throughout the connected potential transformers (PT) and current transformers (CT). PT and CT secondary circuits are capable of generating lethal voltages and currents with their primary circuits energized. Follow standard safety precautions while performing any installation or service work (i.e. removing PT fuses, shorting CT secondaries, ...etc).
- Do not use the meter for primary protection functions where failure of the device can cause fire, injury or death. The meter should only be used for shadow protection if needed.
- Under no circumstances should the meter be connected to a power source if it is damaged.
- To prevent potential fire or shock hazard, do not expose the meter to rain or moisture.
- Setup procedures must be performed only by qualified personnel familiar with the instrument and its associated electrical equipment.
- DO NOT open the instrument under any circumstances.

### **Limited warranty**

- CET offers the customer a minimum of 12-month functional warranty on the meter for faulty parts or workmanship from the date of dispatch from the distributor. This warranty is on a return to factory for repair basis.
- CET does not accept liability for any damage caused by meter malfunctions. CET accepts no responsibility for the suitability of the meter to the application for which it was purchased.
- Failure to install, set up or operate the meter according to the instructions herein will void the warranty.
- Only CET's duly authorized representative may open your meter. The unit should only be opened in a fully anti-static environment. Failure to do so may damage the electronic components and will void the warranty.

## Table of Contents

Chapter 1 Introduction .....	6
1.1 Overview .....	6
1.2 Features.....	6
1.3 Applications.....	6
1.4 Getting more information .....	7
Chapter 2 Installation .....	8
2.1 Appearance .....	8
2.2 Unit Dimensions .....	9
2.3 Terminal Dimensions .....	9
2.4 Mounting.....	9
2.5 Input Wiring .....	10
2.6 RS-485 Wiring.....	10
2.7 Energy Pulse Output Wiring .....	11
Chapter 3 Front Panel.....	12
3.1 LCD Display .....	12
3.1.1 LED Pulse Output .....	12
3.1.2 LCD Display Symbols .....	12
3.2 LCD Testing .....	12
3.3 Display Screen Types .....	12
3.4 Setup Configuration via the Front Panel .....	13
3.4.1 Functions of buttons .....	13
3.4.2 Setup Menu .....	14
3.4.3 Configuration .....	14
Chapter 4 Modbus Register Map.....	15
4.1 Basic Measurements .....	15
4.2 Energy Measurements .....	15
4.3 Device Setup.....	16
4.3.1 Basic Setup Parameters.....	16
4.3.2 Communication Setup Parameters .....	16
4.4 Time.....	16
4.5 Clear Control .....	16
4.6 Meter Information.....	17
Appendix A Technical Specifications.....	18
Appendix B Standards Compliance.....	19
Appendix C Ordering Guide .....	20
Contact us.....	21

## Chapter 1 Introduction

This manual explains how to use the PMC-220 Single-Phase Multifunction Meter. Throughout the manual the term “meter” generally refers to all models.

This chapter provides an overview of the PMC-220 meter and summarizes many of its key features.

### 1.1 Overview

The PMC-220 Single-Phase Multifunction Meter is CET’s latest offer for the low voltage energy metering market featuring DIN Rail mount, compact construction, 63A direct connect input and high accuracy measurements. The PMC-220 complies with the IEC 62053-21: 2020 Class 0.5 kWh Accuracy Standard. In addition, the PMC-220 has received the Certificate of Approval from the National Measurement Institute (NMI) of Australia and been verified by UL with reference to NMI M6-1 Electricity Meters, Part 1: Metrological and Technical Requirements. With the standard RS-485 port and Modbus RTU protocol, the PMC-220 becomes a vital component of an intelligent, multifunction monitoring solution for any Energy Management Systems.

You can setup the meter via our free PMC Setup software. The meter is also supported by our PecStar® Integrated Energy Management System.

### 1.2 Features

- IEC 62053-21: 2020 Class 0.5 Compliant and NMI M6-1 Class 1 Certified
- Direct Input up to 63A without external CT
- Low starting Current @ 20mA
- Multifunction measurements
  - Voltage, Current, kW, kvar, kVA, PF and Frequency
  - kWh and kvarh Imp/Exp/Tot/Net and kVAh
  - Device Operating Time (Running Hour)
  - Front Panel & Communication Programming Counters
- 8-digit Multifunction LCD Display
- Self-powered, no external control power required
- kWh LED Pulse Output
- Solid State Pulse Output @ 1000 imp/kWh
- Standard RS-485 port with Modbus RTU support
- Easy installation with DIN Rail mounting, no tools required

### 1.3 Applications

The PMC-220 can be used to monitor a 2-wire single-phase circuit. Modbus RTU communications allow real-time data and other information to be transmitted across a RS-485 network to an Integrated Energy Management System such as PecStar® iEMS.

The PMC-220 comes standard with one Front Panel LED Pulse Output and one Solid State Pulse Outputs for kWh and kvarh pulsing. Energy Pulse Outputs are typically used for accuracy testing. Energy pulsing can be enabled via communications or through the Front Panel. The pulse constant is 1000 imp/kWh (1 pulse per Wh) and pulse width is fixed at 80ms±20ms.

The PMC-220 comes with an 8-digit LCD display for the kWh Imp/Exp, kvarh Imp/Exp and kVAh counters with a resolution of 0.01 kWh and a maximum value of 1,000,000.00. When the maximum value is reached, it will automatically roll over to zero. The kWh counter can be reset manually via communications or the Front Panel and preset to a user-defined value only via communications.

The following figure illustrates a typical application where the PMC-220s are used in an Energy Management System.

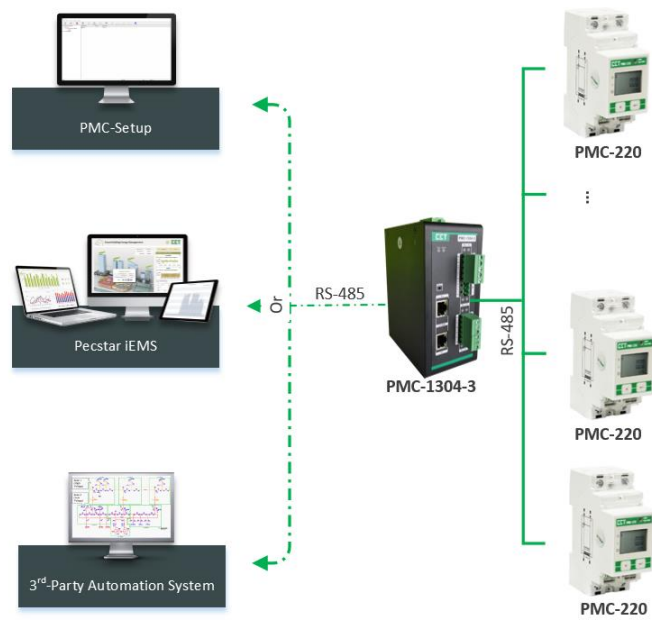

#### 1.4 Getting more information

Additional information is available from CET via the following sources:

- Visit [www.cet-global.com](http://www.cet-global.com)
- Contact your local representative
- Contact CET directly via email or telephone

## Chapter 2 Installation



### Caution

Installation of the PMC-220 should only be performed by qualified, competent personnel that have the appropriate training and experience with high voltage and current devices. The meter must be installed in accordance with all local and national electrical codes.

During the operation of the meter, hazardous voltages are present at the input terminals. Failure to observe precautions can result in serious or even fatal injury and equipment damage.

### 2.1 Appearance



Figure 2-1 Appearance



## 2.2 Unit Dimensions

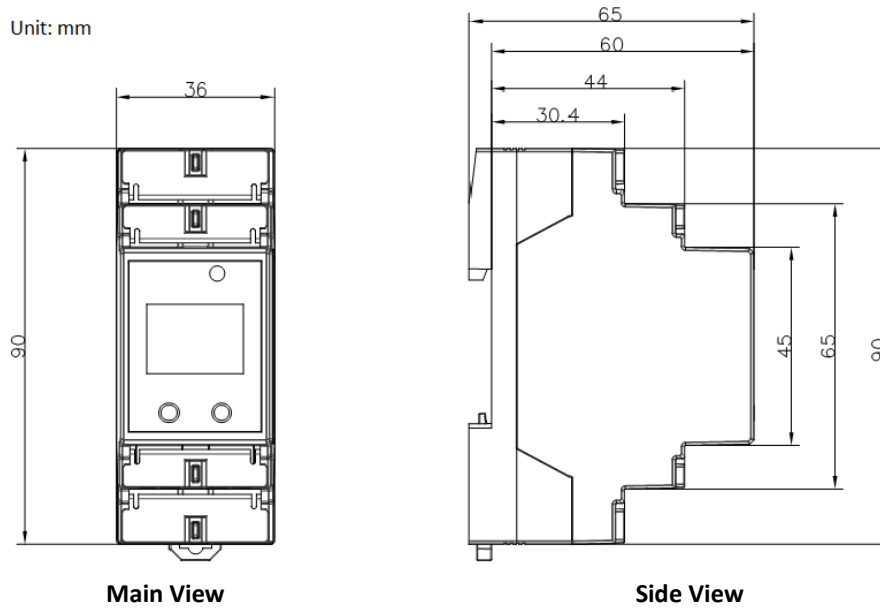

Figure 2-2 Unit Dimensions

## 2.3 Terminal Dimensions

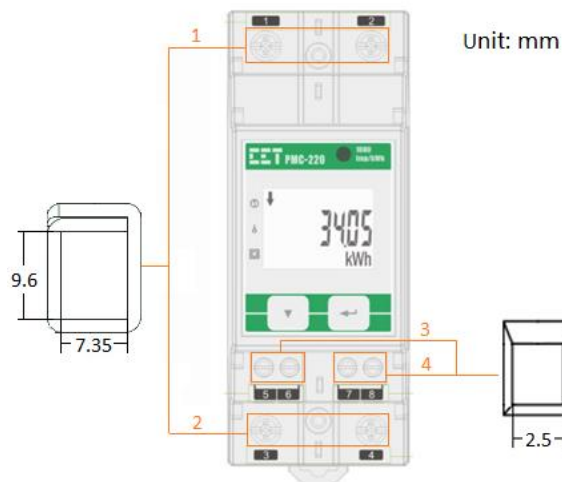

Figure 2-3 Terminal Dimensions

	Terminal	Terminal Dimensions	Max. Wire Size	Max. Torque
1	Input (L, N)	7.35mm x 9.6mm	25.0mm <sup>2</sup>	25.0 kgf.cm/M3 (21.7 lb-in)
2	Output (L', N')			
3	Pulse Output	2.5mm x 2.8mm	1.5mm <sup>2</sup>	4.5 kgf.cm/M3 (3.9 lb-in)
4	RS-485			

Table 2-1 Terminal Dimensions

## 2.4 Mounting

The PMC-220 should be installed in a dry environment with no dust and kept away from heat, radiation and electrical noise source.

Installation steps:

- Before installation, make sure that the DIN Rail is already in place
- Move the installation clip at the bottom of the PMC-220 downward to the “unlock” position
- Mount the PMC-220 on the DIN Rail
- Push the installation clip upward to the “lock” position to secure the PMC-220 on to the DIN Rail

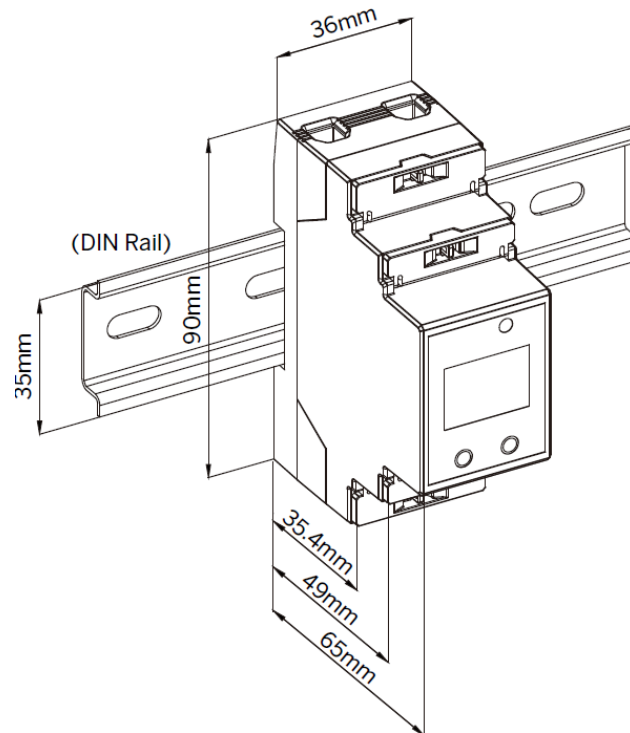

Figure 2-4 Installation

## 2.5 Input Wiring

Please consult the serial number label to ensure that the voltage and current input is less than or equal to the meter's input specification.

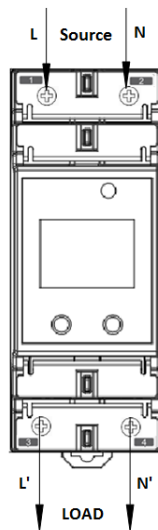

Figure 2-5 Input connections

## 2.6 RS-485 Wiring

The PMC-220 provides one standard RS-485 port and supports the Modbus RTU protocol. Up to 32 devices can be connected on a RS-485 bus. The overall length of the RS-485 cable connecting all devices should not exceed 1200m.

If the master station does not have a RS-485 communications port, a RS-232/RS-485 or USB/RS-485 converter with optically isolated outputs and surge protection should be used. The following figure illustrates the RS-485 communications connections on the PMC-220.

Each PMC-220 comes with a 120Ω Termination Resistor. It is recommended that a single termination resistor be used at the end of the RS-485 bus to prevent signal reflection.

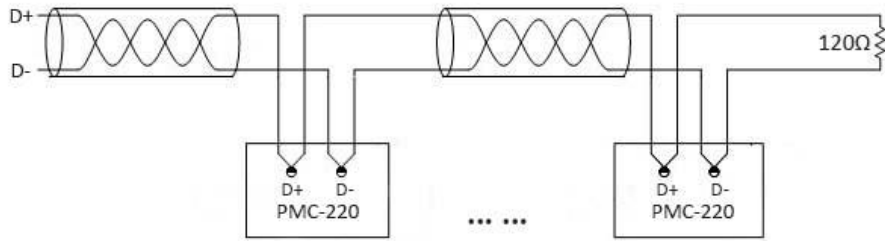

Figure 2-6 RS-485 Connections

## 2.7 Energy Pulse Output Wiring

The following figure illustrates the Pulse Output connection on the PMC-220.

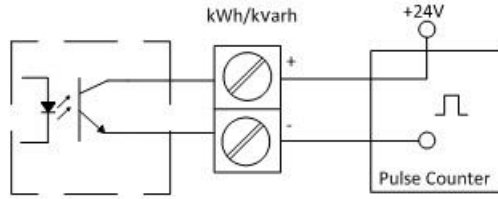

Figure 2-7 Energy Pulse Output Connections

## Chapter 3 Front Panel

The meter’s front panel is used for both display and configuration purposes. The LCD display screen and two buttons allow quick access to view measurements and meter information, configure the parameters and perform maintenance.

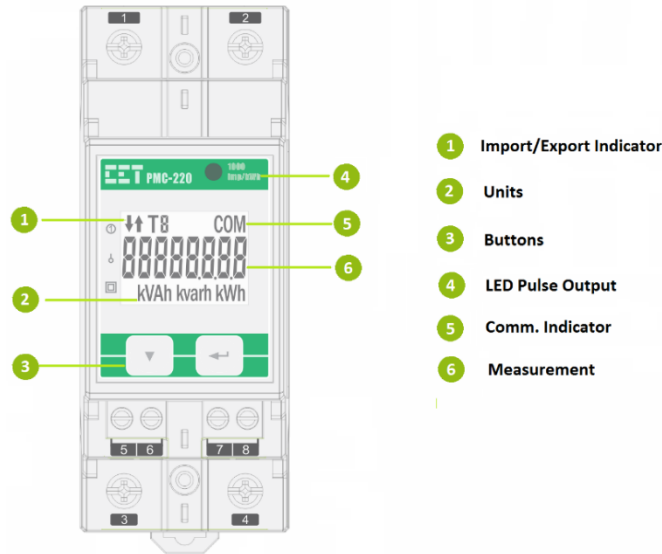

Figure 3-1 Front Panel Display

### 3.1 LCD Display

#### 3.1.1 LED Pulse Output

The PMC-220 comes standard with a LED Pulse Output on its front panel, labeled **1000 Imp/kWh**. The LED Pulse Output is used for kWh pulsing if the **PULSE** is ENABLED.

#### 3.1.2 LCD Display Symbols

The following table shows the special LED display symbols:

Label	Description					

Table 3-1 LCD Display Symbols

### 3.2 LCD Testing

Pressing both the <↔> and the <▼> buttons simultaneously for 2 seconds enters the **LCD Test** mode. During testing, all LCD segments are illuminated and will blink on and off three times before returning to the **Data Display** mode.

### 3.3 Display Screen Types

The PMC-220 has a default display which can be set as one of two modes: **Fixed** mode which displays kWh Imp statically and **Energy Auto-Scroll** mode which displays kWh Imp, kWh Exp, kvarh Imp, kvarh Exp and kVAh in sequence in 4 seconds interval. The **Energy Auto-Scroll** setup parameter can only be

set via communications.

In **Data Display** mode, pressing the <▼> button scrolls to the next parameter while pressing the <↔> button toggles among **Basic Measurements**, **Energy Measurements** and **Programming Counters**.

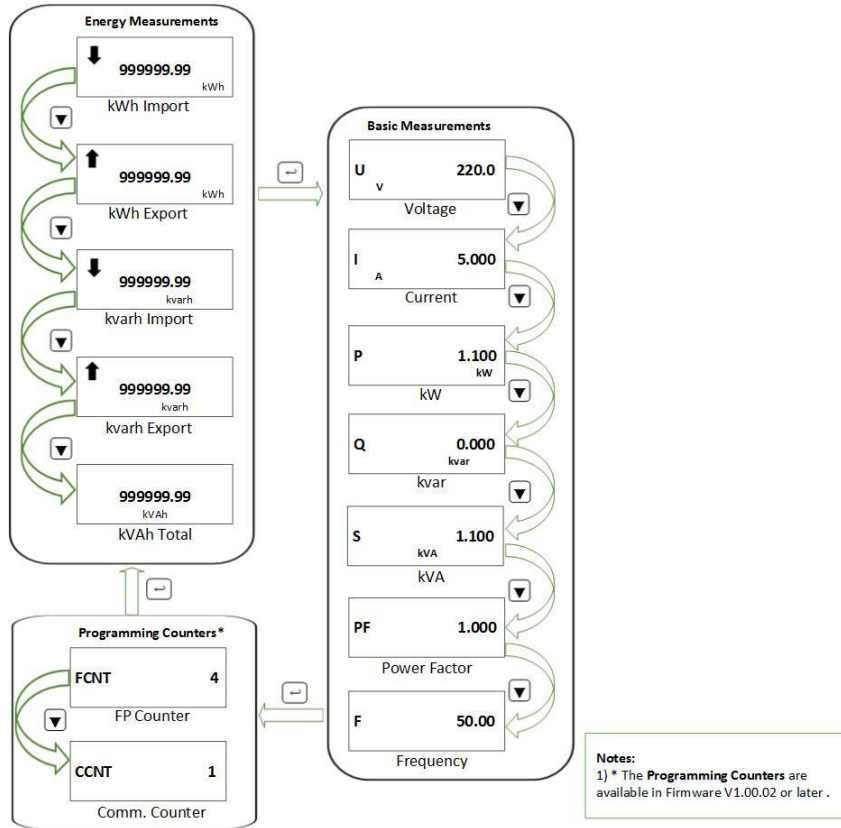

Figure 3-2 Measurements Screen

### 3.4 Setup Configuration via the Front Panel

Pressing the <↔> button for two seconds enters the **Setup Configuration** mode where the setup parameters can be changed. Upon completion, pressing the <↔> button for two seconds returns to the **Data Display** mode.

#### 3.4.1 Functions of buttons

The two front panel buttons take on different meanings in the **Setup Configuration** mode and are described below:

<↔>: Pressing this button for two seconds toggles between **Data Display** mode and **Setup Configuration** mode. Once inside the **Setup Configuration** mode and at the main menu, pressing this button selects a parameter for modification. Once selected, the parameter value blinks while it's being changed. If the selected parameter is a numeric value, pressing this button shifts the cursor to the left by one position. When the cursor has reached the left-most digit, pressing this button again will save the new setting into memory. The parameter will also stop blinking once the value has been saved.

<▼>: Before an item is selected, pressing this button scrolls to the next setup parameter. If the selected parameter is a numeric value, pressing this button increments the selected digit. If the selected parameter is an enumerated value, pressing this button scrolls through the enumerated list. Pressing the <↔> button will save the current enumerated value.

#### Making setup changes:

- Press the <↔> button for two seconds to enter the **Setup Configuration** mode.
- Press the <▼> button to advance to the Password page.
- A correct password must be entered before changes are allowed. The factory default password

is zero. Press the <▼> button to select the parameter for modification. Use the <▼> and <↔> buttons to enter the correct password.

- Use the <▼> button to scroll to the desired parameter.
- Press the <↔> button to select the parameter. Once selected, the parameter value will blink.
- Use the <↔> and <▼> buttons to make modification to the selected parameter.
- Pressing the <↔> button for two seconds to exit the **Setup Configuration** mode.

### 3.4.2 Setup Menu

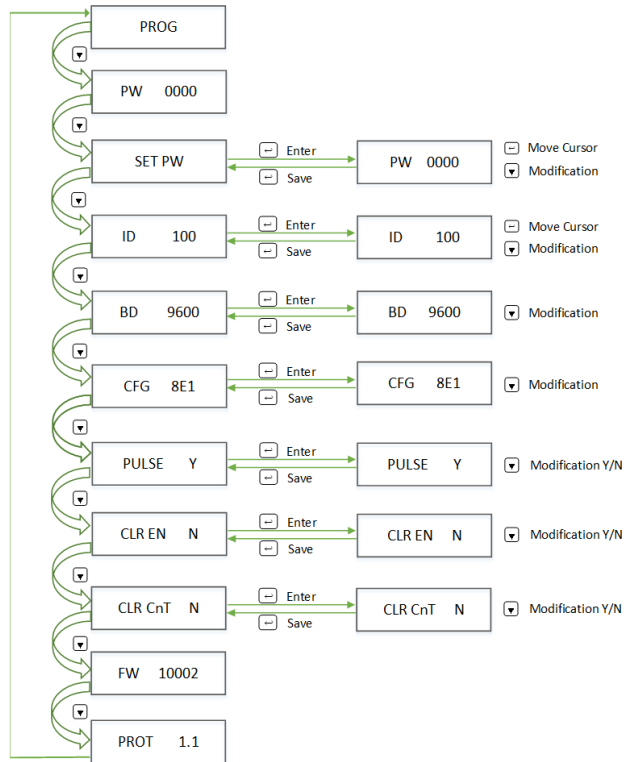

Figure 3-3 Setup Menu

### 3.4.3 Configuration

The Setup Configuration mode provides access to the following setup parameters:

Label	Parameters	Description	Option (value)	Default
PROG	Programming	Setup Configuration Mode	/	/
PW	Password	Enter Password	0~9999	0
SET PW	Set Password	Enter New Password	0~9999	0
ID	Unit ID	Com. Unit ID	1~247	100
BD	Baud Rate	Data rate in bits per second (bps)	1200/2400/4800/ 9600/19200	9600
CFG	Comm. Port Configuration	Data Format	8N2/8O1/8E1/8N1	8E1
PULSE	Energy Pulsing	Enable Energy Pulsing	YES/NO	NO
CLR EN		Clear Energy	YES/NO	NO
CLR CnT*		Clear FP Counter and Comm. Counter	YES/NO	NO
FW	Version	Firmware Version	For example, 10002 means the firmware version is V1.00.02.	/
PROT	Protocol	Protocol Version	e.g. 1.1 means V1.1	/

\*Available in Firmware V1.00.02 or later

Table 3-2 Setup Parameters

## Chapter 4 Modbus Register Map

This chapter provides a complete description of the Modbus register map (**Protocol Version 1.1**) for the PMC-220 to facilitate the development of 3<sup>rd</sup> party communications driver for accessing information on the PMC-220. The PMC-220 supports the following Modbus functions:

- 1) Read Holding Registers (Function Code 0x03)
- 2) Preset Multiple Registers (Function Code 0x10)

For a complete Modbus Protocol Specification, please visit <http://www.modbus.org>.

The following table provides a description of the different data formats used for the Modbus registers. The PMC-220 uses the Big Endian byte ordering system.

Format	Description
UINT16/INT16	Unsigned/Signed 16-bit Integer
UINT32/INT32	Unsigned/Signed 32-bit Integer
Float	IEEE 754 32-bit Single Precision Floating Point Number

### 4.1 Basic Measurements

Register	Property	Description	Format	Scale	Unit
0000	RO	V	Float	x1	V
0002	RO	I	Float		A
0004	RO	kW	Float		kW
0006	RO	kvar	Float		kvar
0008	RO	kVA	Float		kVA
0010	RO	P.F.	Float		-
0012	RO	Frequency	Float		Hz
0014~0037		Reserved			
0038	RO	FP Counter* <sup>1</sup>	UINT16	x1	
0039	RO	Comm. Counter* <sup>2</sup>	UINT16		

\*Available from Firmware V1.00.02 or later

**Table 4-1 Basic Measurements**

**Notes:**

- 1) The **FP Counter** is incremented every time the **Clear Energy** action is performed via the Front Panel.
- 2) The **Comm. Counter** is incremented every time the **Clear Energy** action is performed or the **CT Polarity** is changed via communications.

### 4.2 Energy Measurements

Register	Property	Description	Format	Scale	Unit
0040	RW	kWh Import	INT32	x0.01	kWh
0042	RW	kWh Export	INT32		
0044	RO	kWh Net	INT32		
0046	RO	kWh Total	INT32	x0.01	kvarh
0048	RW	kvarh Import	INT32		
0050	RW	kvarh Export	INT32		
0052	RO	kvarh Net	INT32		
0054	RO	kvarh Total	INT32	x0.01	kVAh
0056	RW	kVAh	INT32		

**Table 4-2 Energy Measurements**

**Notes:**

- 1) The Energy registers have a maximum value of 100,000,000 in units of 0.01 kXh (1,000,000.00) and will roll over to zero automatically when it is reached.
- 2) The kXh Imp, Exp and Total registers' values are positive, and the kXh Net registers' can be either positive or negative, where a positive value means kXh Imp is greater than kXh Exp while a negative value means kXh Exp is greater than kXh Imp.
- 3) The kXh counter can be reset manually via communications or the front panel and preset to a user-defined value only via communications.

### 4.3 Device Setup

#### 4.3.1 Basic Setup Parameters

Register	Property	Description	Format	Range/Default*
6000	RW	PF Convention	UINT16	0=IEC*, 1=IEEE, 2=-IEEE
6001	RW	CT Polarity <sup>1</sup>	UINT16	0=Normal*, 1=Reversed
6002	RW	Solid State Pulse Output <sup>2</sup>	UINT16	0=Disabled, 1=kWh Imp* 2=kWh Exp, 3=kWh Total 4=kvarh Imp, 5=kvarh Exp 6=kvarh Total
6003	RW	LED Pulse Output Enable	UINT16	0=Disabled, 1=Enabled*
6004	RW	Default Display <sup>3</sup>	UINT16	0=kWh Import* 1=Energy Auto-Scroll

Table 4-3 Basic Setup Parameters

**Notes:**

- 1) CT Polarity can only be changed via communications.
- 2) The Pulse Constant is fixed at 1000 imp/kXh.
- 3) The **Energy Auto-Scroll** mode displays the following energy measurements in sequence in 4 seconds interval: kWh Import, kWh Export, kvarh Import, kvarh Export and kVAh.

#### 4.3.2 Communication Setup Parameters

Register	Property	Description	Format	Range/Default*
6100			Reserved	
6101	RW	Unit ID	UINT16	1 to 247, 100*
6102	RW	Baud Rate	UINT16	0=1200, 1=2400, 2=4800 3=9600*, 4=19200
6103	RW	Comm. Config.	UINT16	0=8N2, 1=8O1 2=8E1*, 3=8N1

Table 4-4 Communication Setup

### 4.4 Time

There are two sets of Time registers supported by the PMC-220 – Year / Month / Day / Hour / Minute / Second (Register # 60000 to 60002) and UNIX Time (Register # 60004). When sending time to the PMC-220 over Modbus communications, care should be taken to only write one of the two Time register sets. All registers within a Time register set must be written in a single transaction. If registers 60000 to 60004 are being written to at the same time, both Time register sets will be updated to reflect the new time specified in the UNIX Time register set (60004) and the time specified in registers 60000-60002 will be ignored. Writing to the Millisecond register (60003) is optional during a Time Set operation. When broadcasting time, the function code must be set to 0x10 (Pre-set Multiple Registers). Incorrect date or time values will be rejected by the meter. In addition, attempting to write a Time value less than Jan 1, 2000 00:00:00 will be rejected.

Register	Property	Description	Format	Note
60000	9000	RW	UINT16	High-order Byte: Year
				Low-order Byte: Month
60001	9001	RW	UINT16	High-order Byte: Day
				Low-order Byte: Hour
60002	9002	RW	UINT16	High-order Byte: Minute
				Low-order Byte: Second
60003	9003	RW	UINT16	0 to 999
60004	9004	RW	UINT32	0x386D4380 to 0x7FE8177F The corresponding time is 2000.01.01 00:00:00 to 2037.12.31 23:59:59 (GMT 0:00 Time Zone)

Table 4-5 Time Registers

### 4.5 Clear Control

Register	Property	Description	Format	Note
9600	WO	Clear Energy	UINT16	Writing "0xFF00" to this register will clear all energy registers.
9601	WO	Clear Programming	UINT16	Writing "0xFF00" to this register will



		Counters*		clear both the FP and Comm. Programming Counters.
--	--	-----------	--	---

\*Available in Firmware V1.00.02 or later

**Table 4-6 Clear Control**

**4.6 Meter Information**

Register Address		Property	Description	Format	Note
60200~60219	9800~9819	RO	Meter model <sup>1</sup>	UINT16	See Note 1
60220	9820	RO	Firmware Version	UINT16	e.g. 10000 shows the version is V1.00.00
60221	9821	RO	Protocol Version	UINT16	e.g. 10 shows the version is V1.0
60222	9822	RO	Firmware Update Date: Year-2000	UINT16	e.g. 140110 means January 10, 2014
60223	9823	RO	Firmware Update Date: Month	UINT16	
60224	9824	RO	Firmware Update Date: Day	UINT16	
60225	9825	RO	Serial Number	UINT32	

**Table 4-7 Meter Information**

**Note:**

- 1) The Meter Model appears in registers 60200 to 60219 and contains the ASCII encoding of the string "PMC-220" as shown in the following table.

Register	Value(Hex)	ASCII
60200	0x50	P
60201	0x4D	M
60202	0x43	C
60203	0x2D	-
60204	0x32	2
60205	0x32	2
60206	0x30	0
60207-60219	0x20	Null

**Table 4-8 ASCII Encoding of "PMC-220"**

## Appendix A Technical Specifications

Measurement Inputs (L, N, L', N')			
Voltage (Un)	220VAC	230VAC	240VAC
Overrange (% Un)	120%	115%	110%
Range (V)	95-264VAC		
Current (Ib/Imax)	5A/63A		
Starting Current (Ist)	0.4% Ib (0.02A)		
Minimum Current (Imin)	5% Ib (0.25A)		
Frequency	45Hz-65Hz		
Power Supply	Self-powered from 95 to 264VAC		
Maximum Wire Size	25 mm <sup>2</sup> (4AWG)		
Torque for L, N Terminals	2.5 N.m		
Communications (D+, D-)			
RS-485 (Modbus RTU)	Optically isolated @ 5kVrms		
Baud Rate	1200/2400/4800/9600/19200 bps		
Maximum Wire Size	1.5mm <sup>2</sup> (16AWG)		
Torque for RS485 Terminals	0.45 N.m		
Pulse Output (E+, E-)			
Type	Optically Isolated Solid State Relay		
Max. Load Voltage	80 VDC		
Max. Forward Current	50 mA		
Pulse Constant	1000 imp/kxh		
Pulse Width	60-100 ms		
Maximum Wire Size	1.5 mm <sup>2</sup> (16AWG)		
Torque for RS485 Terminals	0.45 N.m		
Environmental Conditions			
Operating Temp.	-25°C to +70°C		
Storage Temp.	-40°C to +85°C		
Humidity	5% to 95% non-condensing		
Atmospheric pressure	70kPa to 106kPa		
Pollution Degree	2		
Mechanical Characteristics			
Unit Dimensions	36x65x90mm		
Shipping Weight	0.18kg		
Shipping Dimensions	120x103x42mm		
Mounting	DIN-Rail Mounting		
IP Rating	IP51 (Front), IP30 (Body)		

### Accuracy

Parameters	Accuracy	Resolution
Voltage	±0.5% reading	0.1V
Current	±0.5% reading	0.001A
kW, kVA	±1.0%	0.001kX
kvar	±1.0%	0.001kvar
kWh	IEC 62053-21: 2020 Class 0.5 NMI M6-1 Class 1	0.01kWh
kvarh	IEC 62053-23: 2020 Class 2	0.01kvarh
kVAh	IEC 62053-21: 2020 Class 0.5	0.01kVAh
P.F	±1.0%	0.001
Frequency	±0.02Hz	0.01Hz

**Appendix B Standards Compliance**

Safety Requirements	
CE LVD 2014 / 35 / EU	EN 61010-1: 2010 + A1: 2019 EN 61010-2-030: 2010
Insulation	IEC 62052-31: 2015 NMI M6-1
AC Voltage	4kV @ 1 minute
Impulse voltage	12kV+0%, -15%, 1.2/50µs (NMI M6-1)
Electrical Safety in Low Voltage Distribution Systems up to 1000Vac and 1500Vdc	IEC 61557-12: 2018 (PMD)
Electromagnetic Compatibility EMC 2014/30/EU (EN 61326: 2013)	
Immunity Tests	
Electrostatic discharge	EN 61000-4-2: 2009
Radiated fields	EN 61000-4-3: 2006 + A1: 2008 + A2: 2010
Fast transients	EN 61000-4-4: 2012
Surges	EN 61000-4-5: 2014 + A1: 2017
Conducted disturbances	EN 61000-4-6: 2014
Magnetic Fields	EN 61000-4-8: 2010
Voltage Dips and Interruptions	EN 61000-4-11: 2004 + A1: 2017
Ring Waves	EN 61000-4-12: 2017
Mechanical Tests	
Spring hammer test	IEC 62052-31: 2015
Vibration Test	IEC 62052-11: 2020
Shock Test	IEC 62052-11: 2020
Revenue Metering Approval	
NMI M6-1 of Australia	Approval Mark: NMI 14/2/98 UL Ref. # R11353641-CETA-NMI M6-1

Appendix C Ordering Guide

		<b>CET Electric Technology</b>		<i>Version 20161102</i>			
<b>Product Code</b>			<b>Description</b>				
PMC-220 Digital Single-Phase Energy Meter							
<b>Input Current</b>							
C			5A (63A Max), Direct Input				
<b>Input Voltage</b>							
3			95V-240V AC ±10%				
<b>System Frequency</b>							
5			45Hz-65Hz				
<b>Communications</b>							
A			1xRS-485				
<b>Language</b>							
E			English				
PMC-220	-	C	3	5	A	E	PMC-220-C35AE (Standard Model)

## Contact us

CET Electric Technology Inc.

Email: [Support@cet-global.com](mailto:Support@cet-global.com)

Web: [www.cet-global.com](http://www.cet-global.com)